

Typennummer / Identification

BV-Nr.	BV-Nr.	MDB 400/150	Drosselart	Type of choke	3~ Motor reactor
Typ - Kunde	Type Customer	-	Kernform	Core type	3UI 120/51







Technische Daten / Technical Data

Phasenzahl	No. of phase			3
Schaltgruppe	Circuit type			IIIO
typ. Wicklungswiderstand	typ. Winding resistance	[mΩ]		0.400
Bemessungsspannung	Rated voltage	[V]		0.0 - 690.0
Bemessungsfrequenz	Rated frequency	[Hz]		0.0 - 120.0
Taktfrequenz	Switching frequency	[kHz]		2.0 - 6.0
Induktivität L	Inductance L	[mH]		0.050
L Toleranz	L tolerance	[%]		10
Bemessungsstrom	Rated current	[A]		150.0
Linear bis Spitzenstrom Is	L linear up to	[A]		300.0
Verlustleistung	Power Loss	[W]		-
Prüfspannung	Test voltage	[kV]		4.8

Betriebsbedingungen / Operating conditions

Schutzart	Protection index			IP 00
Umgebungstemperatur	Ambient temperature	[°C]		-10 40
Temperaturklasse VDE	Class ISO °C VDE			F (155°C)
Temperaturklasse UL	Class ISO °C UL			class 155
Kühlungsart	Type of cooling			AN
Luftgeschwindigkeit	Air speed	[m/s]		-
Einschaltdauer	Duty cycle	[%]		100

Ausführung / Standards

Typ / Type:	Datum / Date	Zeichen / Signs
EN 61558-1 +AC +A1 EN 61558-2-20	2005 + 2006 + 2009 2011	 
BS EN 61558-2-20	2011	
UL 5085 CSA 22.2	2006	 E103521 (max.600V / only 50-60Hz)
WEEE 2012/19/EU	2012	
SJ/T 11363-2006 (China-RoHS)	2006	
RoHS 2011/65/EU RoHS 2015/863/EU	2011 2015	

Bemerkung / Notes

Die angegebenen technischen Daten sind typisch.
Material- und fertigungsbedingt können Abweichungen auftreten.

Technical specifications are typical.
They can vary due to material and production tolerances.

Date: **22.05.2023**
11:39
Name: **Lehnen**
Date: **22.05.2023**
11:48
Checked: **Eilers**

Schutzvermerk gemäß ISO 16016 beachten

Observe protection clause to ISO 16016

Datei **000718297**
Änderung **0**
Abteilung **EWN**

Temperaturreduzierung / Derating

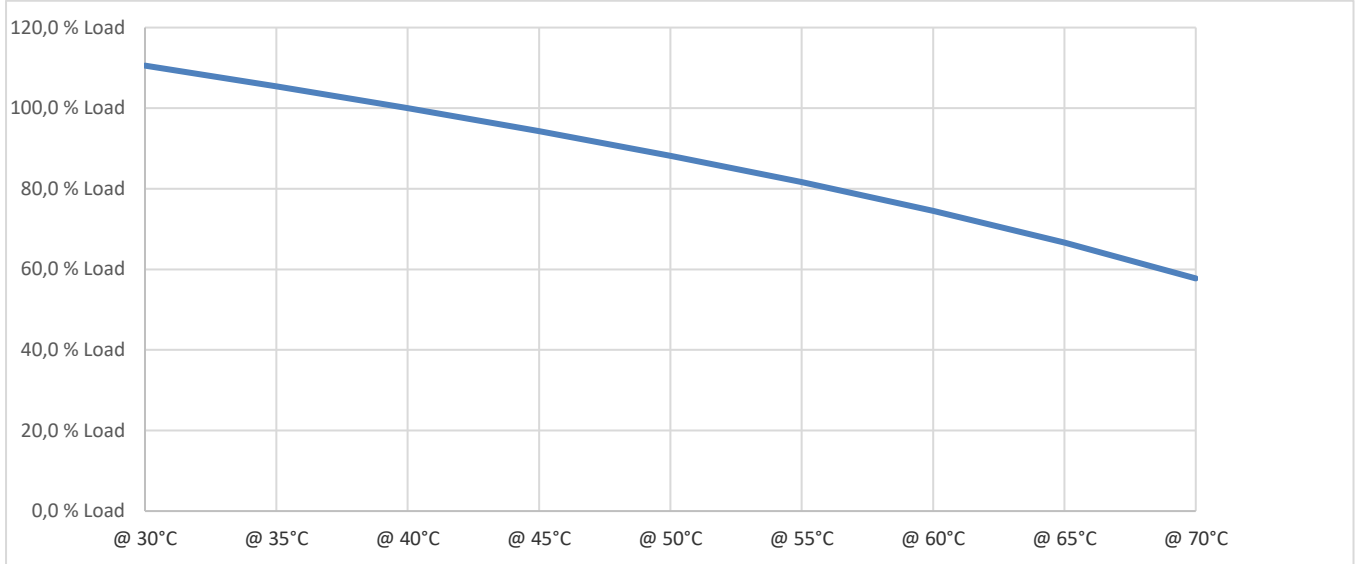

Leistungsreduzierung / Power reduction

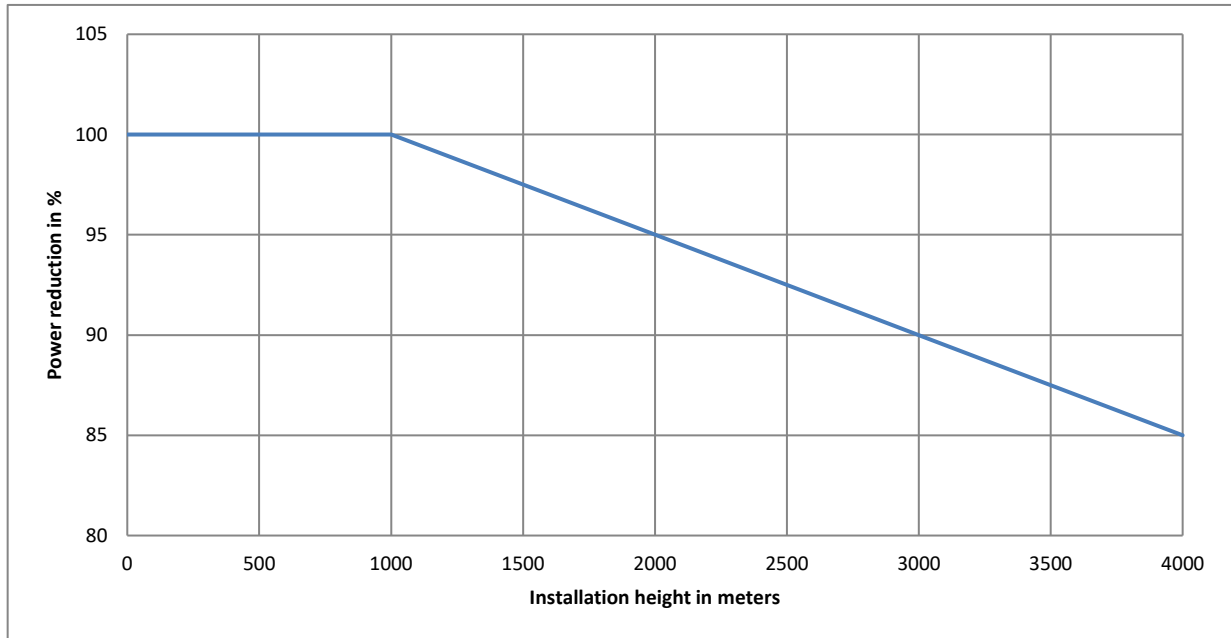

Date: **22.05.2023**
11:39
Name: **Lehnen**
Date: **22.05.2023**
11:48
Checked: **Eilers**

Schutzvermerk gemäß ISO 16016 beachten

Observe protection clause to ISO 16016

Datei **000718297**
Änderung **0**
Abteilung **EWN**

Abmessungen / Dimensions

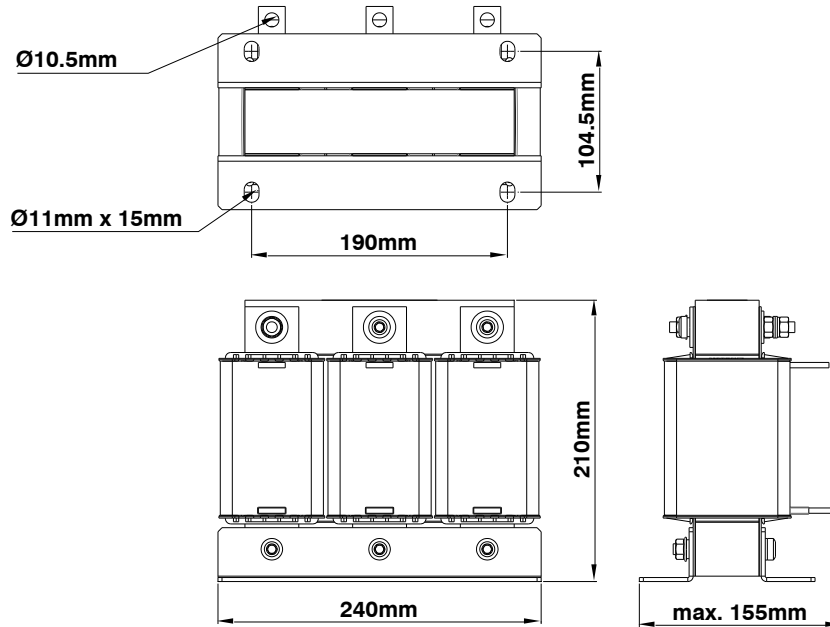

Gewichte / Weights

Gewicht (netto)	Weight	[kg]	19.500
Wicklungsgewicht	Weight of windings	[kg]	5.8
Wickelmaterial	Winding material		CU

Anschlüsse / Terminals

Eingang	Input		Flachkupferanschluss mit Bohrung für Schraube M10 Busbar terminal with hole for screw M10
Ausgang	Output		Flachkupferanschluss mit Bohrung für Schraube M10 Busbar terminal with hole for screw M10
PE Anschluss	PE Terminal	Bolzen / Bolt	M8

Anzugsmomente / torque

Eingang	Input	[Nm]	30
Ausgang	Output	[Nm]	30
PE Anschluss	PE Terminal	[Nm]	12.0

Bemerkung / Notes

Einzelheiten der Darstellung in der Aufbauskinne sind unverbindlich.
Allgemeintoleranzen DIN 2768-m
Änderungen vorbehalten.
* = Typisch variiert durch Luftspalteinlage

Technical specifications in the drawing are not binding.
General tolerance to DIN 2768-m.
Subject to change
* = Typical variable air gap

Date: **22.05.2023**
11:39
Name: **Lehnen**
Date: **22.05.2023**
11:48
Checked: **Eilers**

Schutzvermerk gemäß ISO 16016 beachten

Observe protection clause to ISO 16016

Datei **000718297**
Änderung **0**
Abteilung **EWN**