

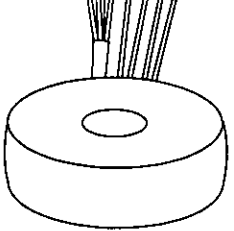



Index:	Baureihe: Type:	RKD
a	Art.-Nr.: Art.-No.:	RKD 800/2x115

Datenblatt
Technical
Specifications

Typ	: 1~ Trenntransformator		
Type	: 1~ Isolating transformer		
Kernform	: Ringbandkern		
Core type	: Torroidal		
Bemessungsspannung, Eingang	: 2x115V		
Designated input voltage			
Bemessungsstrom, Eingang	: 3,62Aac		
Designated input current			
Bemessungsspannung, Ausgang	: 2x 115V		
Designated output voltage			
Bemessungsstrom, Ausgang	: 3,48Aac		
Designated output current			
Vorzusehende Absicherung, Ausgang	:  4,0AT		
Recommended output fuse			
Einschaltdauer	: 100%		
Duty cycle			
Bemessungsleistung (bei Leistungsfaktor 1)	: 800VA		
Designated output power (power factor 1)			
Verlustleistung	: ca. 35,0W ($\eta \sim 95,8\%$)		
Power loss	: approx.		
Schaltgruppe	: IIIi0		
Connection mode			
Betriebsfrequenz	: 50-60Hz		
Designated frequency			
Schutzklasse	: vorbereitet für Geräte der Schutzklasse II		
Safety class	: prepared for class II equipment		
Schutzart	: IP00		
Protection index			
Kühlungsart	: AN		
Type of cooling			
Isolierstoffklasse	: B (UL class 105)		
Insulation class			
Max. Umgebungstemperatur	: 40°C		
Ambient temperature			
Vorschriften	: EN 61558 Teil 1 mit Teil 2-4		
Standards	: EN 61558 part 1 with part 2-4		
Prüfzeichen	:  UL 5085, CSA 22.2 (E 103521)		
Approvals			
Prüfspannung	: Primär-Sekundär 4,8 kV Sekundär-Sekundär 1,0 kV		
HV-Test voltage	: Primary-Secondary Secondary-Secondary		
	: Primär-Primär 0,3 kV		
	: Primary-Primary		
Anschluß (Eingang)	: 20-21cm UL/CSA-Litze Style 1015 AWG 16		
Terminal (Input)	: 20-21cm UL/CSA- AWM style 1015 AWG 16		
Anschluß (Ausgang)	: 20-21cm Drahtenden mit Gewebeschauch		
Terminal (Output)	: 20-21cm wire insulated with glass reinforced sleeving		
Bemerkungen	: Die angegebenen technischen Daten sind typisch. Material-und		
Notes	: fertigungsbedingt können Abweichungen auftreten.		
	: Technical specifications are typical,		
	: they can vary due to material and production tolerances.		

a	Date: 25.04.13	Name: Schlee	Date: 26.4.13	Checked: 	Amendment: Power loss added, HV-Test voltage changed
Date: 29.06.10	Date: 30.07.10	Schutzvermerk nach ISO 16016 beachten			Änderungen vorbehalten Subject to change
Name: Jochade	Checked: Clasen	Observe protection clause to ISO 16016			

Boreihe: **RKD**
Type:

Art.-Nr.: **RKD 800/2x115**
Art.-No.:

Datenblatt

Technical
Specifications

BLOCK
Transformatoren-Elektronik
GmbH
D - 27283 Verden/Alt

Anschlußkennzeichnung: Terminal Identification

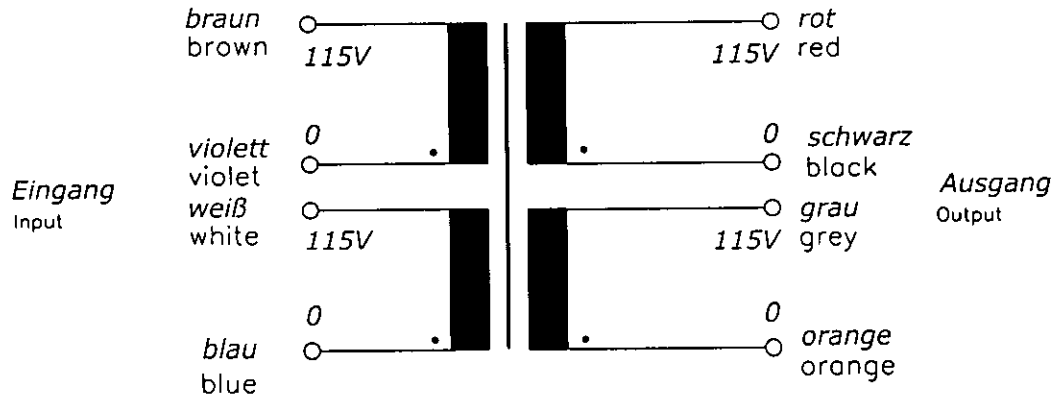

Abmessungen: Dimensions

Außen-Ø ca. 170mm im Bereich der Ausführungen ca. 172mm
Outer-Ø approx. 170mm over leadouts approx. 172mm

Höhe max. 72mm zzgl. 5mm Montageset
Height max. 72mm plus 5mm mounting kit

Gewicht: ca. 7,0kg
Weight: approx. 7.0kg

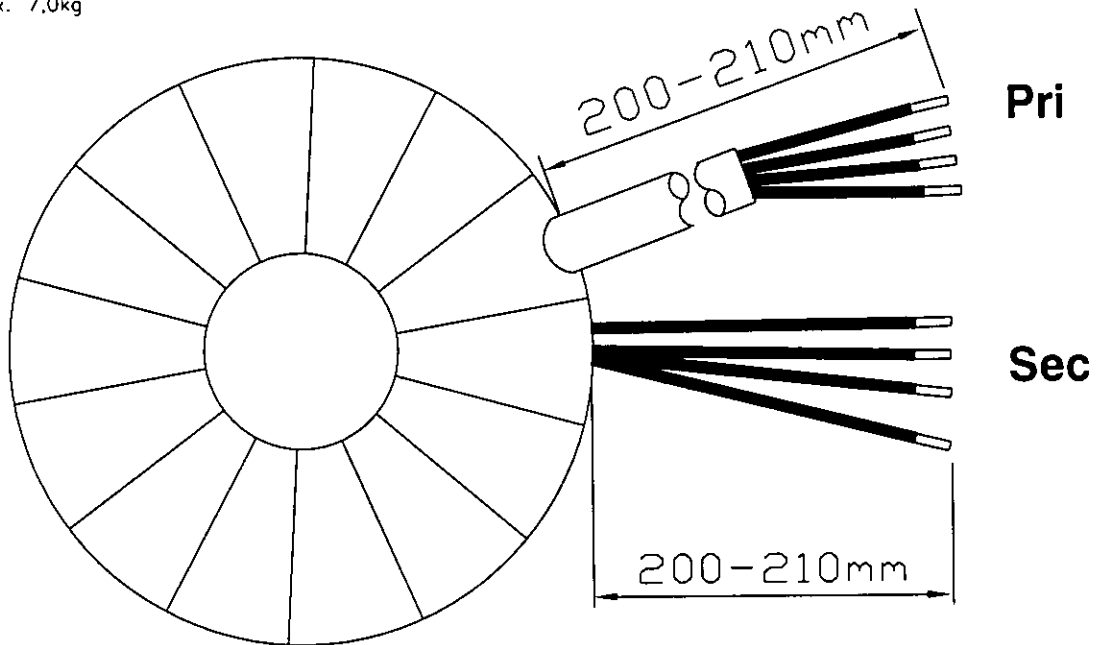

Befestigung mit (beiliegend): Mounting with (enclosed)

1x Befestigungscheibe
1x Mounting plate

2x Gummischeibe
2x Rubber disc

1x Schraube M8 + Scheibe + Mutter
1x Screw M8 + washer + nut

Seite 2/2
Page 2/2